

Chapter

11

Oral and Maxillofacial Surgery Instruments

PERIOSTEAL ELEVATOR—MOLT

FUNCTION: To detach the periosteum from bone following an incision or to detach the gingival tissues from around the neck of the tooth prior to placement of extraction forceps

FEATURES: Double ended with one round, blunted end and one pointed end

TRAY SET-UP: Used for most surgical procedures: extractions, gingivoplasty, alveoplasty, cyst removal

CLINICAL APPLICATION: 7A wax spatula or a Woodson #1 plastic instrument is sometimes used if a smaller periosteal elevator is desired



Image courtesy of Hu-Friedy, www.hu-friedy.com

STRAIGHT ELEVATORS

FUNCTION: To loosen tooth or root from bony socket prior to placement of the extraction forceps

FEATURES: Straight handle and working end
Single rounded working end in several sizes
Often referred to by number—common sizes: 1, 34, 301

TRAY SET-UP: Tooth and root extraction

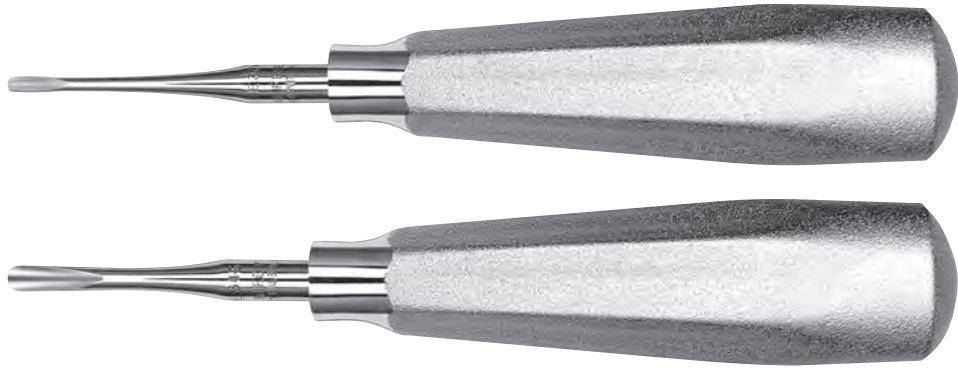

Images courtesy of Hu-Friedy, www.hu-friedy.com

ANGULAR ELEVATORS—CRYER

FUNCTION: To loosen tooth or root from bony socket prior to placement of the extraction forceps

FEATURES: Handles may be either large and straight or T-bar/crossbar design
Pointed working end in several sizes
Paired, right and left
Also called a “flag” elevator
Other common designs: Potts and Crane

TRAY SET-UP: Tooth and root extraction, impaction



Images courtesy of Hu-Friedy, www.hu-friedy.com

ANGULAR ELEVATORS—POTTS

FUNCTION: To loosen tooth or root from bony socket prior to placement of the extraction forceps

FEATURES: Handles may be either large and straight or T-bar/crossbar design
Rounded working end in several sizes
Paired, right and left
Other common designs: Cryer and Crane

TRAY SET-UP: Tooth and root extraction, impaction

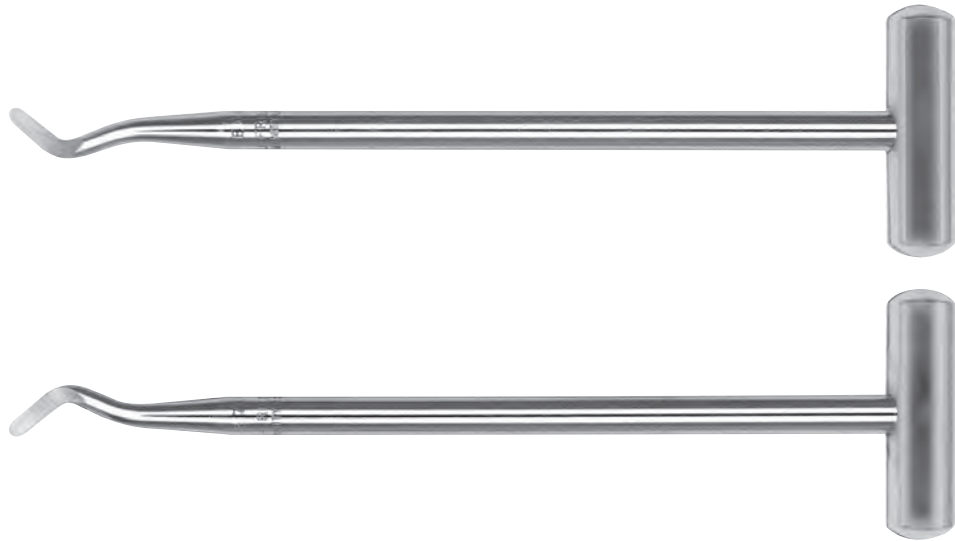

Images courtesy of Hu-Friedy, www.hu-friedy.com

ANGULAR ELEVATORS—CRANE

FUNCTION: To loosen tooth or root from bony socket prior to placement of the extraction forceps

FEATURES: Large straight handle
Nonpaired, universal
Other common designs: Cryer and Potts

TRAY SET-UP: Tooth and root extraction, impaction



Image courtesy of Hu-Friedy, www.hu-friedy.com

ROOT TIP PICKS—ANGLED

FUNCTION: To loosen small root fragments from bony socket

FEATURES: Small elevator with thin, pointed, angled working end
Single or double ended

TRAY SET-UP: Tooth and root extraction, impaction

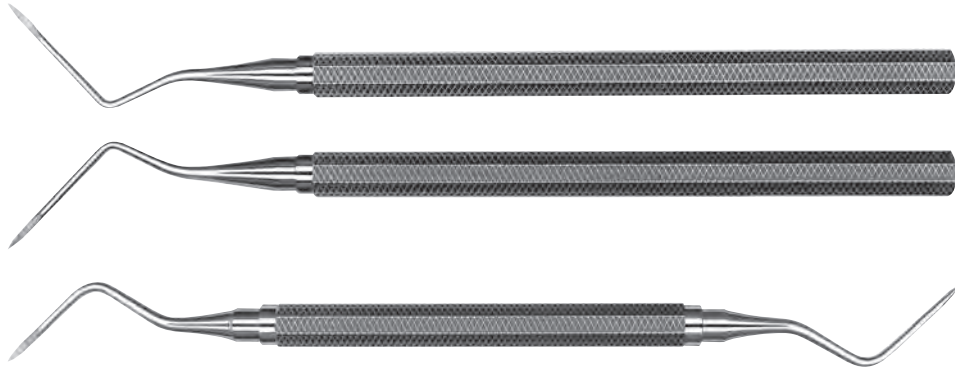

Images courtesy of Hu-Friedy, www.hu-friedy.com

ROOT TIP PICKS—STRAIGHT

FUNCTION: To loosen small root fragments from bony socket

FEATURES: Small elevator with thin, pointed, straight working end
Single or double ended

TRAY SET-UP: Tooth and root extraction, impaction



Image courtesy of Hu-Friedy, www.hu-friedy.com

SURGICAL CURETTES—DOUBLE ENDED/ANGULAR

FUNCTION: To remove tissue or debris from bony sockets

FEATURES: Spoon-shaped scraping instrument
Usually double ended and angular in several sizes

TRAY SET-UP: Extraction, impaction, and cyst removal

CLINICAL APPLICATION: Used following tooth extraction to ensure removal of debris and diseased tissue



Image courtesy of Premier Dental Products, www.premusa.com

SURGICAL CURETTES—MOLT

FUNCTION: To remove tissue or debris from bony sockets

FEATURES: Single rounded working end with larger diameter handle

TRAY SET-UP: Extraction, impaction, cyst removal

CLINICAL APPLICATION: Molt #1 (pictured) also used to retract tissue flaps following incision



Image courtesy of Hu-Friedy, www.hu-friedy.com

HEMOSTATS

FUNCTION: To securely hold small items, clamp blood vessels, and remove small pieces of tooth or bone

FEATURES: Angled or straight with locking, scissor-like handles

Common names: Mosquito, Kelly

Available in 4³/₄", 5¹/₂", 6¹/₄", and 7¹/₂"

TRAY SET-UP: Almost all surgical set-ups

CLINICAL APPLICATION: Ratchet-type handles require some practice to open and close smoothly
Very versatile instrument used in all areas of dentistry



Images courtesy of Hu-Friedy, www.hu-friedy.com

NEEDLE HOLDERS

FUNCTION: To hold suture needle

FEATURES: Similar to hemostat but with a concave area on inside of each beak to allow for curve of suture needle

TRAY SET-UP: Any surgical procedure involving an incision will require placement of sutures

CLINICAL APPLICATION: To avoid needle breakage, place the needle holder on the needle just beyond the suture attachment point and at right angles to the curve of the needle

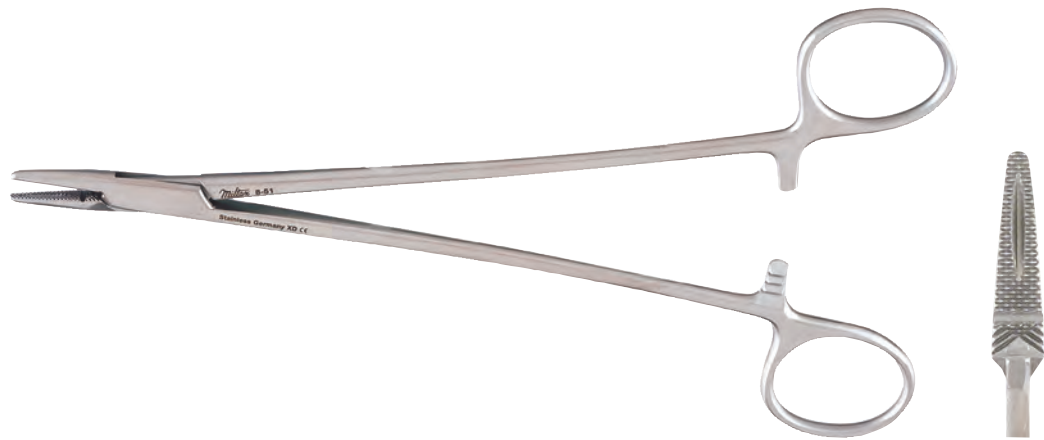

Images courtesy of Miltex, www.miltex.com

SUTURE

FUNCTION: To close incision site
“Stitches” hold tissues in place during healing

FEATURES: Suture material attached to sterile stainless steel needle
Different sizes and designs of needles
Suture may be absorbable—plain or chromic gut, polyglycolic acid (PGA, Vicryl) or nonabsorbable—silk, polyester, nylon, polypropylene
Sized by diameter of suture material: 3-0 (000), 4-0 (0000), 5-0 (00000) most common sizes used in dentistry (smaller number = larger diameter)

CLINICAL APPLICATION: Nonabsorbable sutures usually removed at 7–10 days postsurgical visit
Placed with needle holder or hemostat

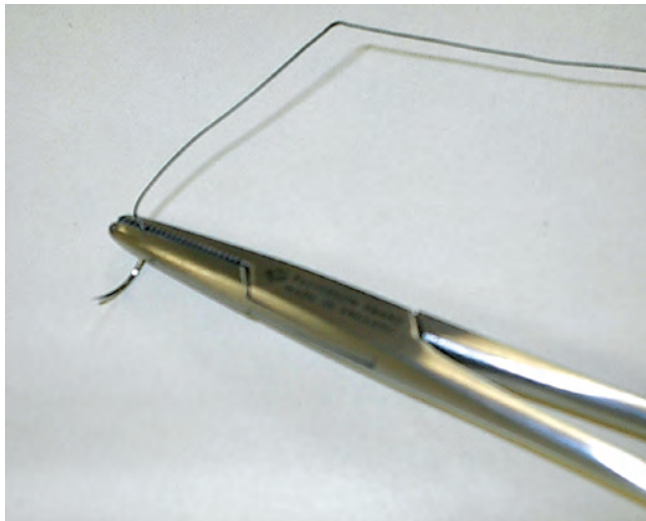
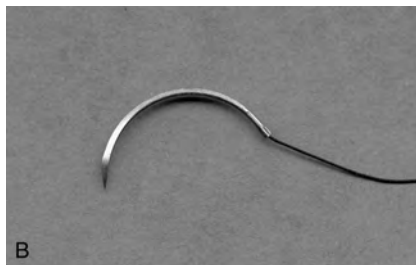

SCALPEL

FUNCTION: To cut soft tissue—a surgical knife

FEATURES: Often referred to as “Bard-Parker” or “BP”
Individually sterile wrapped for single use
Common blade sizes: #11 (a), #12 (b), #15 (c)
Metal, sterilizable handle for replaceable blades (d)
Disposable scalpel consisting of a plastic handle with attached blade (e)

TRAY SET-UP: Most surgical set-ups: impaction, extraction, biopsy, frenectomy, gingivoplasty, alveoplasty, incision and drainage, and apicoectomy

CLINICAL APPLICATION: For safety, blades are placed and removed from the metal handle with a hemostat or a specially designed scalpel blade remover
Used blades should be disposed of in a sharps container

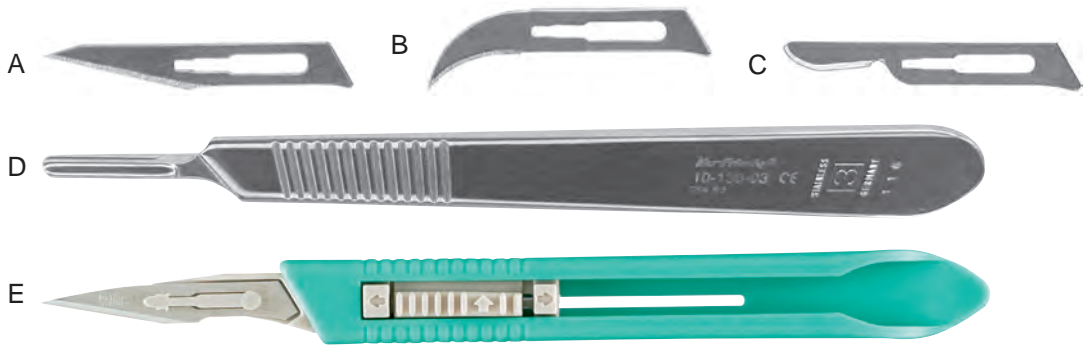

(A–D) Images courtesy of Hu-Friedy, www.hu-friedy.com, and (E) courtesy of Miltex, www.miltex.com

SCALPEL BLADE REMOVER

FUNCTION: To safely remove blade from scalpel handle



Image courtesy of Hu-Friedy, www.hu-friedy.com

RONGEURS—SIDE-CUTTING

FUNCTION: To cut and contour bone—removes sharp edges of alveolar crest after extractions for better contour of alveolar ridge; removes exostoses

FEATURES: Scissor-type handle, cutting edges on side and top of beaks

TRAY SET-UP: Multiple extractions, alveolectomy/alveoplasty

CLINICAL APPLICATION: During use, bone will accumulate around cutting edges. Assistant should wipe working ends with 4 × 4 periodically to remove debris.



Images courtesy of Hu-Friedy, www.hu-friedy.com

RONGEURS—END-CUTTING

FUNCTION: To cut and contour bone—removes sharp edges of alveolar crest after extractions for better contour of alveolar ridge; removes exostoses

FEATURES: Scissor-type handle, cutting edges on top edge of beaks

TRAY SET-UP: Multiple extractions, alveolectomy/alveoplasty

CLINICAL APPLICATION: During use, bone will accumulate around cutting edges. Assistant should wipe working ends with 4 × 4 periodically to remove debris.



Image courtesy of Hu-Friedy, www.hu-friedy.com

BONE CHISEL AND MALLET

FUNCTION: To remove bone for better contour of alveolar ridge; remove exostoses, i.e., tori

TRAY SET-UP: Tori removal, alveoplasty



Images courtesy of Hu-Friedy, www.hu-friedy.com

BONE FILE

FUNCTION: To smooth bone for better contour of alveolar ridge, often following use of rongeurs

FEATURES: Straight or curved working ends
Crosscut or straight cutting ridges
Double ended

TRAY SET-UP: Multiple extractions and impactions that require bone removal, tori removal, alveoplasty

CLINICAL APPLICATION: During use, bone will accumulate around cutting edges. Assistant should wipe working ends with 4 × 4 periodically to remove debris.

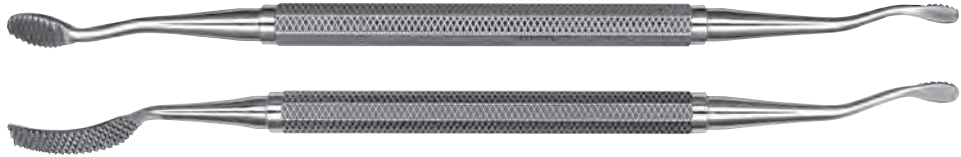

Images courtesy of Hu-Friedy, www.hu-friedy.com

TISSUE SCISSORS—DEAN

FUNCTION: To cut and remove excess or diseased soft tissue
Also used to cut sutures after knots are tied during suture placement

FEATURES: 6½"
Other common varieties of tissue scissors: Kelly, Iris

TRAY SET-UP: Gingivectomy/Gingivoplasty, frenectomy, multiple extractions



Image courtesy of Hu-Friedy, www.hu-friedy.com

TISSUE SCISSORS—IRIS

FUNCTION: To cut and remove excess or diseased soft tissue
Also used to cut sutures after knots are tied during suture placement

FEATURES: Straight or curved, 4" and 4½"
Other common varieties of tissue scissors: Dean, Kelly

TRAY SET-UP: Gingivectomy/gingivoplasty, frenectomy, multiple extractions



Images courtesy of Miltex, www.miltex.com

TISSUE SCISSORS—KELLY

FUNCTION: To cut and remove excess or diseased soft tissue
Also used to cut sutures after knots are tied during suture placement

FEATURES: Straight or curved, 6¼" and 7"
Other common varieties of tissue scissors: Dean, Iris

TRAY SET-UP: Gingivectomy/gingivoplasty, frenectomy, multiple extractions



Images courtesy of Miltex, www.miltex.com

SUTURE SCISSORS

FUNCTION: To cut sutures for removal

FEATURES: One curved, hook-like tip to slip under suture
Holds suture away from tissue while cutting
3½", 4½", 5½", and 6"

TRAY SET-UP: Suture removal

CLINICAL APPLICATION: Suture removal often performed by the dental assistant. Wipe area clean with moistened 2 × 2, place curved scissor beak under suture near the knot, then grasp the knot with cotton plier or hemostat, and pull the suture out.



Images courtesy of Hu-Friedy, www.hu-friedy.com

TOWEL CLAMPS

FUNCTION: To secure surgical drapes and to secure plastic and rubber tubing to drapes

FEATURES: Sharp prong tips

3½" and 5¼"

Additional use: Remove metal temporary crowns

TRAY SET-UP: Any procedure when face and head are draped to isolate surgical area



Image courtesy of Hu-Friedy, www.hu-friedy.com

TISSUE RETRACTOR—AUSTIN

FUNCTION: To deflect and retract the periosteum from bone following an incision

FEATURES: L-shaped with one rounded end and one forked end
Other common designs: Seldin, Senn

TRAY SET-UP: All surgical procedures



Image courtesy of Hu-Friedy, www.hu-friedy.com

TISSUE RETRACTOR—SENN

FUNCTION: To deflect and retract the periosteum from bone following an incision

FEATURES: Double ended with one rounded and one forked end
Other common designs: Austin, Seldin

TRAY SET-UP: All surgical procedures



Image courtesy of Miltex, www.miltex.com

TISSUE RETRACTOR/PERIOSTEAL ELEVATOR—SELDIN

FUNCTION: To deflect and retract a tissue flap from bone following an incision

FEATURES: Double ended with round, blunted ends

TRAY SET-UP: Used for most surgical procedures: extractions, gingivoplasty, alveoplasty, cyst removal



Image courtesy of Hu-Friedy, www.hu-friedy.com

TONGUE AND CHEEK RETRACTOR—MINNESOTA

FUNCTION: To hold tongue and cheek away from surgical site
Other common designs: Shuman, Weider

TRAY SET-UP: All surgical procedures



TONGUE AND CHEEK RETRACTOR—SHUMAN

FUNCTION: To hold tongue and cheek away from surgical site
Other common designs: Minnesota, Weider

TRAY SET-UP: All surgical procedures



Image courtesy of Hu-Friedy, www.hu-friedy.com

TONGUE AND CHEEK RETRACTOR—WEIDER

FUNCTION: To hold tongue and cheek away from surgical site
Other common designs: Minnesota, Shuman

TRAY SET-UP: All surgical procedures



Image courtesy of Karl Schumacher Dental Instruments Company, Inc., www.karlschumacher.com

MOUTH PROP—BITE-BLOCK

FUNCTION: To keep mouth open with extensive procedures, sedated or disabled patients

FEATURES: Sterilizable rubber block in four sizes for children and adults
Other common design: mouth gag

TRAY SET-UP: Any procedure when patient may have difficulty keeping mouth open



Images courtesy of Hu-Friedy, www.hu-friedy.com

MOUTH PROP—MOUTH GAG

FUNCTION: To keep mouth open with extensive procedures, sedated or disabled patients

FEATURES: Ratchet design with rubber tips
Other common design: bite-block

TRAY SET-UP: Any procedure when patient may have difficulty keeping mouth open



Image courtesy of Hu-Friedy, www.hu-friedy.com

SURGICAL ASPIRATING TIP—BYRD SELF-CLEANING

FUNCTION: To maintain a clear working field by removing saliva, blood, and debris

FEATURES: Built-in stylet to clear tip of bone or tooth fragments
Available in several diameters
Other common designs: Frazier, Cogswell

TRAY SET-UP: All surgical procedures



Image courtesy of Hu-Friedy, www.hu-friedy.com

SURGICAL ASPIRATING TIP—COGSWELL

FUNCTION: To maintain a clear working field by removing saliva, blood, and debris

FEATURES: Vacuum relief hole controls suction by covering/uncovering the hole with fingertip
Other common designs: Byrd, Frazier

TRAY SET-UP: All surgical procedures

CLINICAL APPLICATION: Tips are cleaned with long, flexible cleaning brushes



Image courtesy of Hu-Friedy, www.hu-friedy.com

SURGICAL ASPIRATING TIP—FRAZIER

FUNCTION: To maintain a clear working field by removing saliva, blood, and debris

FEATURES: Removable stylet to clear tip of bone or tooth fragments
Vacuum relief hole controls suction by covering/uncovering the hole with fingertip
Available in several diameters
Other common designs: Byrd, Cogswell

TRAY SET-UP: All surgical procedures

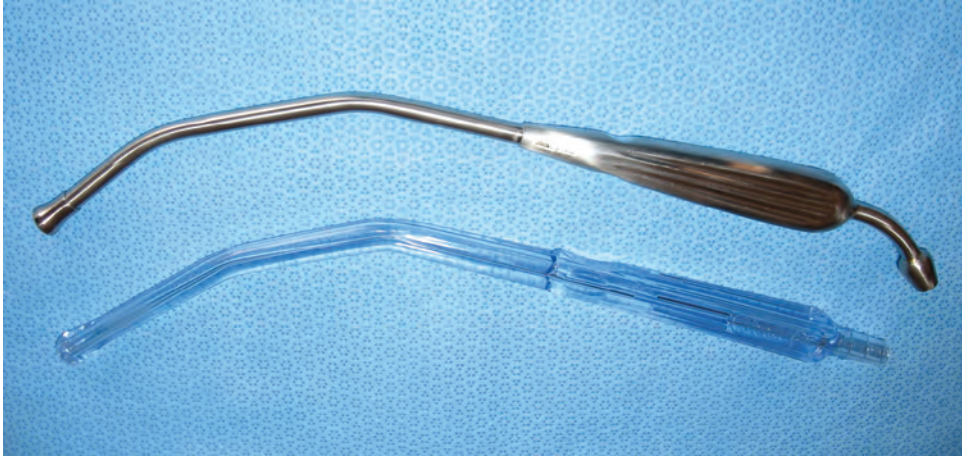

Image courtesy of Hu-Friedy, www.hu-friedy.com

SURGICAL ASPIRATING TIP—YANKEUR TONSIL ASPIRATOR

FUNCTION: To suction throat when using general anesthesia

FEATURES: Angled with perforated ball-type end for suctioning throat



TISSUE PLIERS—ADSON

- FUNCTION:** To grasp and stabilize soft tissue flaps during suturing and reconstructive procedures such as gingival grafting
- FEATURES:** Similar in overall appearance to cotton pliers
Various serrated tips for securely grasping tissue flaps
- TRAY SET-UP:** Any surgical procedure requiring an incision and suturing



Image courtesy of Hu-Friedy, www.hu-friedy.com

TISSUE FORCEPS—ALLISON

FUNCTION: To grasp and stabilize soft tissue flaps during suturing and reconstructive procedures such as gingival grafting

FEATURES: Hemostat-type handles, serrated tips

TRAY SET-UP: Any surgical procedure requiring an incision and suturing



Image courtesy of Hu-Friedy, www.hu-friedy.com

EXTRACTION FORCEPS—#99 MAXILLARY ANTERIORS AND PREMOLARS

FUNCTION: To remove teeth from bony socket

FEATURES: Straight handle and beaks

Beaks designed to conform to facial and lingual root contour just apical to cervical line

Universal (both beaks same design-fit equally well on facial and lingual) for right and left quadrants

TRAY SET-UP: Extraction



Images courtesy of Hu-Friedy, www.hu-friedy.com

EXTRACTION FORCEPS—#150 (CRYER) MAXILLARY ANTERIORS AND PREMOLARS

FUNCTION: To remove teeth from bony socket

FEATURES: Beaks designed to conform to facial and lingual root contour just apical to cervical line

Universal (both beaks same design-fit equally well on facial and lingual) for right and left quadrants

Maxillary counterpart to #151 Mandibular Cryer

TRAY SET-UP: Extraction

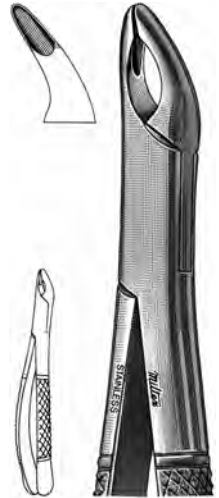

Images courtesy of Miltex, www.miltex.com

EXTRACTION FORCEPS—#18R MAXILLARY RIGHT FIRST AND SECOND MOLARS

FUNCTION: To remove teeth from bony socket

FEATURES: Each beak has different design to adapt to the maxillary molar roots that differ anatomically on the facial and lingual

Rounded beak contours to lingual root

Pointed beak contours to bifurcation of mesial–buccal and distal–buccal root #18R and #53R are essentially the same instrument except that #18R has one curved handle while both handles are straight on #53R

TRAY SET-UP: Extraction



Images courtesy of Miltex, www.miltex.com

EXTRACTION FORCEPS—#18 L MAXILLARY LEFT FIRST AND SECOND MOLARS

FUNCTION: To remove teeth from bony socket

FEATURES: Each beak has different design to adapt to the maxillary molar roots that differ anatomically on the facial and lingual

Rounded beak contours to lingual root

Pointed beak contours to bifurcation of mesial–buccal and distal–buccal root #18L and #53L are essentially the same instrument except that #18L has one curved handle while both handles are straight on #53L

TRAY SET-UP: Extraction

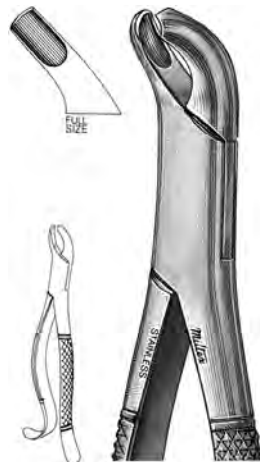

Images courtesy of Miltex, www.miltex.com

EXTRACTION FORCEPS—#53R MAXILLARY RIGHT FIRST AND SECOND MOLARS

FUNCTION: To remove teeth from bony socket

FEATURES: Bayonet design

Each beak has different design to adapt to the maxillary molar roots that differ anatomically on the facial and lingual

Rounded beak contours to lingual root

Pointed beak contours to bifurcation of mesial–buccal and distal–buccal roots
#53R and #18R are essentially the same instrument except that #18R has one curved handle while both handles are straight on #53R

TRAY SET-UP: Extraction

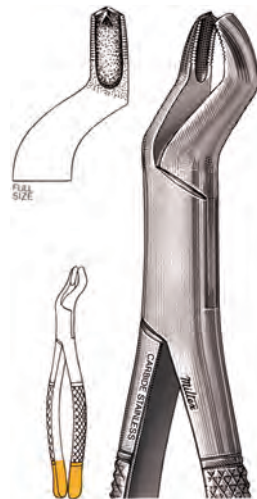

Images courtesy of Miltex, www.miltex.com

EXTRACTION FORCEPS—#53L MAXILLARY LEFT FIRST AND SECOND MOLARS

FUNCTION: To remove teeth from bony socket

FEATURES: Bayonet design

Each beak has different design to adapt to the maxillary molar roots that differ anatomically on the facial and lingual

Rounded beak contours to lingual root

Pointed beak contours to bifurcation of mesial–buccal and distal–buccal roots
#53L and #18L are essentially the same instrument except that #18L has one curved handle while both handles are straight on #53L

TRAY SET-UP: Extraction



Images courtesy of Milten, www.miltex.com



EXTRACTION FORCEPS—#88R MAXILLARY RIGHT FIRST AND SECOND MOLARS

FUNCTION: To remove teeth from bony socket

FEATURES: Bayonet design

Each beak has different design to adapt to the maxillary molar roots that differ anatomically on the facial and lingual

Beak with 1 projection contours to bifurcation of mesial–buccal and distal–buccal roots

Beak with two projections contours to lingual root

TRAY SET-UP: Extraction

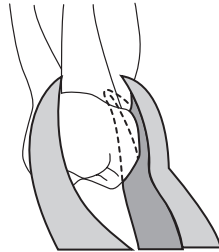

Images courtesy of Hu-Friedy, www.hu-friedy.com

EXTRACTION FORCEPS—#88L MAXILLARY LEFT FIRST AND SECOND MOLARS

FUNCTION: To remove teeth from bony socket

FEATURES: Bayonet design

Each beak has different design to adapt to the maxillary molar roots that differ anatomically on the facial and lingual

Beak with one projection contours to bifurcation of mesial–buccal and distal–buccal roots

Beak with two projections contours to lingual root

TRAY SET-UP: Extraction



A

(A) Image courtesy of Hu-Friedy, www.hu-friedy.com. (B) Image courtesy of Miltex, www.miltex.com

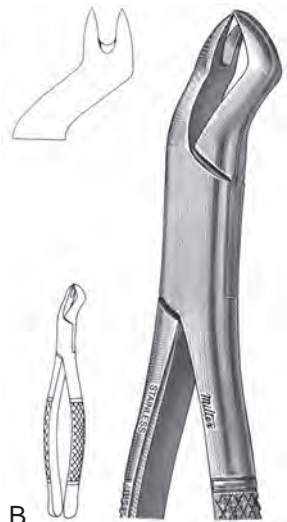

B

EXTRACTION FORCEPS—#210 MAXILLARY THIRD MOLARS

FUNCTION: To remove teeth from bony socket

FEATURES: Bayonet design

Beaks designed to conform to facial and lingual root contour just apical to cervical line

Universal (both beaks same design-fit equally well on facial and lingual) for right and left quadrants

TRAY SET-UP: Extraction



Images courtesy of Miltex, www.miltex.com

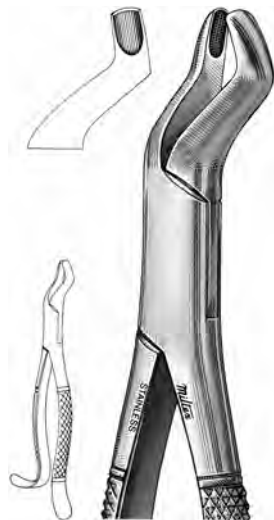

EXTRACTION FORCEPS—#65 MAXILLARY OVERLAPPING ANTERIORS AND ROOT TIPS

FUNCTION: To remove teeth, tooth fragments, and root tips from bony socket

FEATURES: Bayonet design

Universal (both beaks same design-fit equally well on facial and lingual) for right and left quadrants

TRAY SET-UP: Extraction



Images courtesy of Miltex, www.miltex.com

EXTRACTION FORCEPS—#69 MAXILLARY AND MANDIBULAR OVERLAPPING ANTERIORS AND ROOT TIPS

FUNCTION: To remove teeth, tooth fragments, and root tips from bony socket

FEATURES: Universal (both beaks same design-fit equally well on facial and lingual) for right and left quadrants

TRAY SET-UP: Extraction



Images courtesy of Miltex, www.miltex.com

EXTRACTION FORCEPS—#74 MANDIBULAR ROOT TIPS

FUNCTION: To remove tooth fragments and root tips from bony socket

FEATURES: Bird beak design

Universal (both beaks same design-fit equally well on facial and lingual) for right and left quadrants

TRAY SET-UP: Extraction



Images courtesy of Miltex, www.miltex.com



EXTRACTION FORCEPS—#101 ALL DECIDUOUS TEETH AND MANDIBULAR ANTERIORS

FUNCTION: To remove teeth from bony socket

FEATURES: Smaller overall

Beaks designed to conform to facial and lingual root contour just apical to cervical line

Universal (both beaks same design-fit equally well on facial and lingual) for right and left quadrants

TRAY SET-UP: Extraction



Images courtesy of Miltex, www.miltex.com

EXTRACTION FORCEPS—#103 MANDIBULAR ANTERIORS AND PREMOLARS

FUNCTION: To remove teeth from bony socket

FEATURES: Straight handle and beaks

Beaks designed to conform to facial and lingual root contour just apical to cervical line

Universal (both beaks same design-fit equally well on facial and lingual) for right and left quadrants

TRAY SET-UP: Extraction



Image courtesy of Miltex, www.miltex.com

EXTRACTION FORCEPS—#151 (CRYER) MANDIBULAR ANTERIORS AND PREMOLARS

FUNCTION: To remove teeth from bony socket

FEATURES: Beaks designed to conform to facial and lingual root contour just apical to cervical line

Universal (both beaks same design-fit equally well on facial and lingual) for right and left quadrants

Mandibular counterpart to #150 Maxillary Cryer

TRAY SET-UP: Extraction



Images courtesy of Miltex, www.miltex.com

EXTRACTION FORCEPS—#15 MANDIBULAR FIRST AND SECOND MOLARS

FUNCTION: To remove teeth from bony socket

FEATURES: Beaks designed to conform to facial and lingual root contour just apical to cervical line

Universal (both beaks same design-fit equally well on facial and lingual) for right and left quadrants

Pointed beaks contour to bifurcation area of mesial and distal root

#15 and #17 are essentially the same instrument except that #15 has one curved handle while both handles are straight on #17

TRAY SET-UP: Extraction



Images courtesy of Miltex, www.miltex.com



EXTRACTION FORCEPS—#17 MANDIBULAR FIRST AND SECOND MOLARS

FUNCTION: To remove teeth from bony socket

FEATURES: Beaks designed to conform to facial and lingual root contour just apical to cervical line

Universal (both beaks same design-fit equally well on facial and lingual) for right and left quadrants

Pointed beaks contour to bifurcation area of mesial and distal root

#17 and #15 are essentially the same instrument except that #15 has one curved handle while both handles are straight on #17

TRAY SET-UP: Extraction



Images courtesy of Miltex, www.miltex.com

EXTRACTION FORCEPS—#16 MANDIBULAR FIRST AND SECOND MOLARS

FUNCTION: To remove teeth from bony socket

FEATURES: “Cowhorn” forceps

Beaks designed to conform to facial and lingual root contour just apical to cervical line

Universal (both beaks same design-fit equally well on facial and lingual) for right and left quadrants

Pointed beaks contour to bifurcation area of mesial and distal root

#16 and #23 are essentially the same instrument except that #16 has one curved handle while both handles are straight on #23

TRAY SET-UP: Extraction

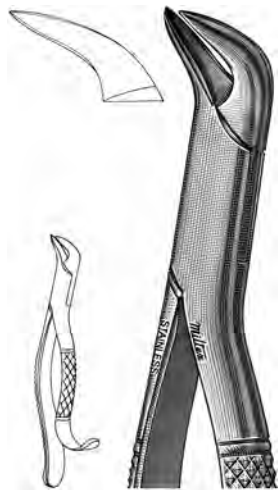

Images courtesy of Miltex, www.miltex.com

EXTRACTION FORCEPS—#23 MANDIBULAR FIRST AND SECOND MOLARS

FUNCTION: To remove teeth from bony socket

FEATURES: “Cowhorn” forceps

Beaks designed to conform to facial and lingual root contour just apical to cervical line

Universal (both beaks same design-fit equally well on facial and lingual) for right and left quadrants

Pointed beaks contour to bifurcation area of mesial and distal root

#23 and #16 are essentially the same instrument except that #16 has one curved handle while both handles are straight on #23

TRAY SET-UP: Extraction

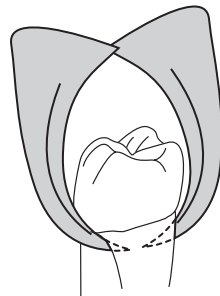

Images courtesy of Hu-Friedy, www.hu-friedy.com

EXTRACTION FORCEPS—#222 MANDIBULAR THIRD MOLARS

FUNCTION: To remove teeth from bony socket

FEATURES: Bayonet design

Beaks designed to conform to facial and lingual root contour just apical to cervical line

Universal (both beaks same design-fit equally well on facial and lingual) for right and left quadrants

TRAY SET-UP: Extraction

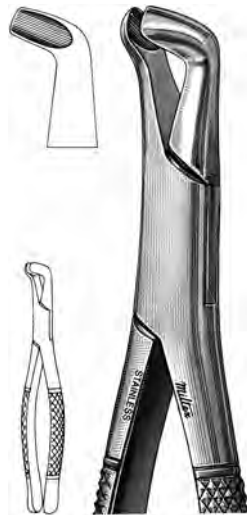

Images courtesy of Miltex, www.miltex.com

SURGICAL HANDPIECE

FUNCTION: To place implants, remove bone, section teeth

FEATURES: Holds sterile water and equipped with pump for oral irrigation
Both straight and contra angle handpiece designs
Variable speed and torque



Image courtesy of Aseptico, www.aseptico.com

LASER (LIGHT AMPLIFICATION BY SIMULATED EMISSION OF RADIATION)

FUNCTION: To remove soft tissue with minimal discomfort and bleeding
Laser also has bacteriocidal effects for enhanced wound healing

APPLICATIONS: Frenectomy, excision of lesions, gingivoplasty, crown lengthening, root canal therapy

CLINICAL APPLICATION: Laser beam is hazardous to eyes and skin. Patient, operator, and assistant must wear special protective goggles and keep hands and body parts away from the beam. Nonshiny instruments should be used to avoid reflection of laser energy. Smoke plume forms as tissue is vaporized; use high volume evacuation during procedure.

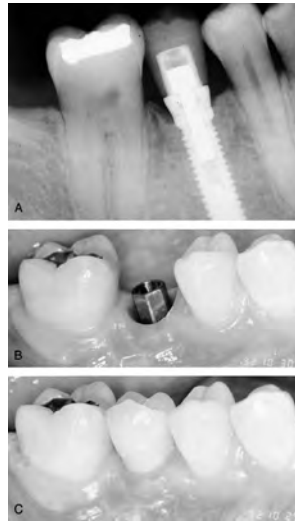
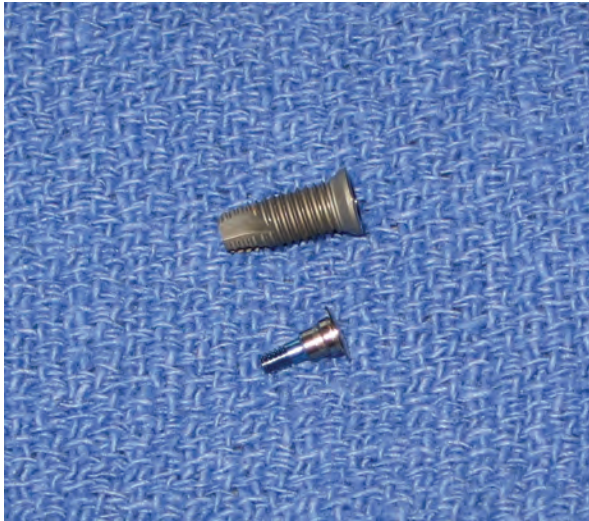

Image courtesy of Sirona Dental Systems, www.sirona.com

ENDOSSEOUS IMPLANT FIXTURE

FUNCTION: To provide a root form for replacement of missing teeth

FEATURES: Cylindrical, screw-shaped device
Made of titanium alloy
Embedded within the alveolar bone
Provides support for a dental crown, bridge, or denture



Photographs courtesy of Ed McGlumphy, D.D.S., M.S.,
Associate Professor, Ohio State University, College of Dentistry.

SURGICAL IMPLANT SITE PREPARATION KIT

FUNCTION: To remove and shape bone for placement of an implant fixture

FEATURES: Multiple “drill” shapes and sizes

CLINICAL APPLICATION: An incision is made and a tissue flap detached to expose the alveolar bone of the implant site. Next, a surgical handpiece is used with the implant site preparation kit to shape a hole for the implant fixture. The implant fixture is placed and covered with the soft tissue flap.

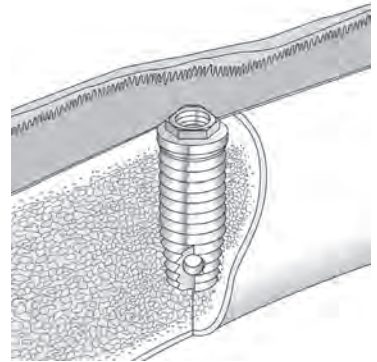

Reprinted with permission from Gladwin MA, Bagby M. Clinical aspects of dental materials: theory, practice, and cases. 3rd ed. Baltimore, MD: Lippincott Williams & Wilkins, 2008.

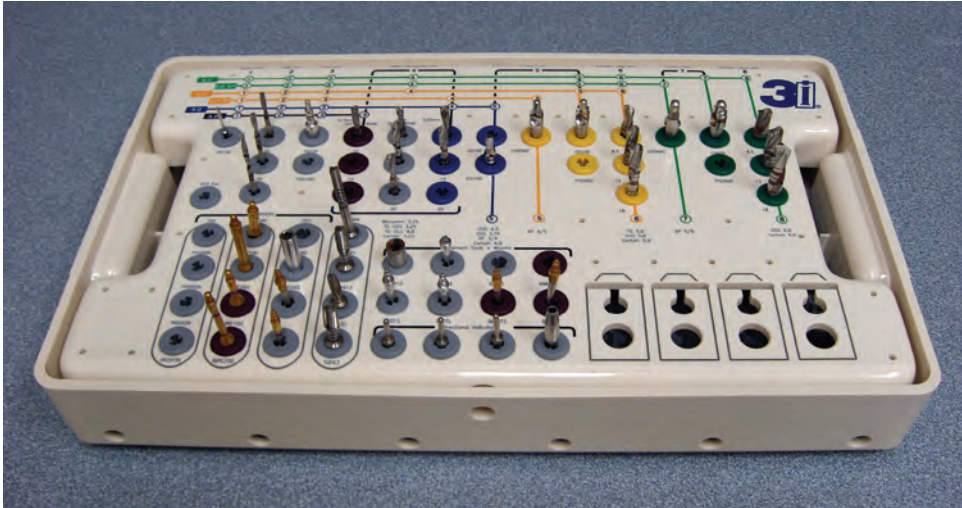

IMPLANT WRENCH/DRIVER

FUNCTION: To place implant screw or healing abutment on implant fixture

CLINICAL APPLICATION: The healing abutment extends above the oral mucosa. After the dental implant is stable and integrated with the bone, the top of the implant is exposed and the healing abutment is placed. The gingiva heals and grows around the abutment creating an esthetic gingival margin for the future implant crown.

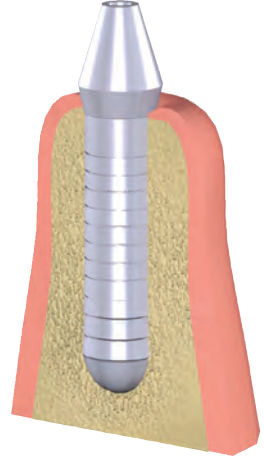

LifeART image copyright ©
2010 Lippincott Williams &
Wilkins. All rights reserved.

BASIC EXTRACTION SET-UP

PURPOSE: To provide instrumentation for surgical removal of tooth/teeth.

- 1.** Local anesthesia syringe, needles, and cartridges
- 2.** Sterile gauze
- 3.** Surgical aspirating tip
- 4.** Cotton pliers
- 5.** Mouth mirror
- 6.** Periosteal elevator
- 7.** Straight elevators
- 8.** Surgical curette
- 9.** Hemostat
- 10.** Extraction forceps (selected for specific tooth/teeth)



MULTIPLE EXTRACTION/ALVEOPLASTY/GINGIVOPLASTY SET-UP

PURPOSE: To provide instrumentation for surgically removing multiple teeth, reshaping bone and gingiva, and placing sutures.

1. Local anesthesia set-up
2. Tissue retractor
3. Scalpel(s)
4. Mouth prop
5. Sterile gauze
6. Surgical aspirating tip
7. Cotton pliers
8. Mouth mirror
9. Periosteal elevator
10. Straight elevators
11. Tissue retractor
12. Surgical curette
13. Bone file
14. Extraction forceps (selected for specific tooth/teeth)
15. Rongeur
16. Tissue scissor
17. Needle holder
18. Hemostat
19. Suture



IMPACTION SET-UP

PURPOSE: To provide instrumentation for surgically removing impacted tooth. Often involves incision and bone removal.

- 1.** Anesthetic syringe, needles, and cartridges
- 2.** Mouth prop
- 3.** Tissue retractor
- 4.** Austin tissue retractor
- 5.** Surgical bur
- 6.** Hemostat
- 7.** Surgical aspirating tip
- 8.** Mouth mirror
- 9.** Cotton pliers
- 10.** Periosteal elevator
- 11.** Straight elevator
- 12.** Crane pick
- 13.** Angular elevators
- 14.** Root tip picks
- 15.** Surgical curette
- 16.** Molt curette
- 17.** Bone file
- 18.** Tissue scissor
- 19.** Extraction forceps
- 20.** Needle holder
- 21.** Scalpel(s)
- 22.** Suture



SUTURE REMOVAL SET-UP

1. Mouth mirror
2. Explorer
3. Suture removal scissors
4. Cotton pliers
5. Oral evacuator tip
6. Air/water syringe tip
7. 2 × 2 gauze



End Chapter 11